

## *Review Article*

### **Desalination Technologies for Developing Countries: A Review**

**A. H. M. Saadat<sup>1\*</sup>, M. S. Islam<sup>1</sup>, M. S. Islam<sup>2</sup>, F. Parvin<sup>1</sup>, A. Sultana<sup>2</sup>**

<sup>1</sup>Department of Environmental Sciences, Jahangirnagar University, Dhaka-1342, Bangladesh

<sup>2</sup>Department of Environmental Biology and Chemistry, Graduate School of Science and Engineering for Research, University of Toyama, Gofuku 3190, Toyama 930–8555, Japan

Received 9 July 2017, accepted in final revised form 12 October 2017

#### **Abstract**

Fresh water is rapidly being exhausted due to natural and anthropogenic activities. The more and more interest is being paid to desalination of seawater and brackish water in order to provide fresh water. The suitability of these desalination technologies is based on several criteria including the level of feed water quality, source of energy, removal efficiency, energy requirement etc. In this paper, we presented a review of different desalination methods, a comparative study between different desalination methods, with emphasis on technologies and economics. The real problem in these technologies is the optimum economic design and evaluation of the combined plants in order to be economically viable for the developing countries. Distillation plants normally have higher energy requirements and unit capital cost than membrane plants and produces huge waste heat. Corrosion, scaling and fouling problems are more serious in thermal processes compare to the membrane processes. On the other hand, membrane processes required pretreatment of the feed water in order to remove particulates so that the membranes last longer. With the continuing advancement to reduce the total energy consumption and lower the cost of water production, membrane processes are becoming the technology of choice for desalination in developing countries.

*Keywords:* Desalination technologies; Economics; Membrane technology; Salinity; Thermal distillation.

© 2018 JSR Publications. ISSN: 2070-0237 (Print); 2070-0245 (Online). All rights reserved.  
doi: <http://dx.doi.org/10.3329/jsr.v10i1.33179> J. Sci. Res. **10** (1), 77-97 (2018)

## **1. Introduction**

Water is a vital resource for the existence of living being on the earth surface and is necessary for economic and social development [1]. Only about 0.5% of the overall global water is available as fresh water while seawater accounts for about 97% of them. In many parts of the world, huge amount of fresh water are required for agricultural, industrial and

---

\* Corresponding author: [ahmsaadat@juniv.edu](mailto:ahmsaadat@juniv.edu)

domestic uses. Now a day, nearly 25% of the humankind is suffering from inadequate fresh water supply [2]. A major study, the Comprehensive Assessment of Water Management in Agriculture discovered that one in three people today face water shortages [3]. The world population is increasing with time which will cause severe water shortages over the next years. The majority of this water shortages burden will fall on people who live in remote rural areas and rapidly expanding urban areas. Most countries in the Near East and North Africa suffer from acute water scarcity, as do countries such as Mexico, Pakistan, South Africa, and large parts of China and India [4]. Lack of accessibility, water quality deterioration, and decline of financial resources, allocation and fragmentation of water management will be the world water challenges for the 21<sup>st</sup> century [5]. Water scarcity will hamper the economic development, devastates human health, leads to environmental degradation, and foments political instability. The annual water availability of 1000 m<sup>3</sup> per capita constitutes the limit below which it will not be possible to guarantee an acceptable living standard as well as economic development [6]. Thus, it is now very important to find out the alternative sources of fresh water in order to cope up with the increasing demand. As a result, a solution such as salt-water desalination has emerged as the keys to sustaining future generations across the globe.

Desalination is a general term for the process that removes dissolved solids and produce fresh water from feed waters such as seawater, brackish water, and inland water and increasingly to reclaim recycled water. It describes a range of processes which are used to reduce the quantity of dissolved solids in water. Fresh water is defined as containing less than 1000 mg/L of salts or total dissolved solids (TDS) [7]. In recent years, increased attention has been drawn to the promise and prospects of desalination technology for alleviating the growing water scarcity. At its simplest, the technology might substantially reduce water scarcity by making the almost inexhaustible stock of seawater and the large quantities of brackish groundwater that appear to be available into new sources of freshwater supply [8]. Factors that have the largest effect on the cost of desalination are feed water quality (salinity levels), product water quality, energy costs as well as economies of scale [9,10]. Seawater desalination is being applied at 57% of installed capacity worldwide, followed by brackish water desalination accounting for 23% of installed capacity [11,12]. Table 1 outlines the global desalting capacity by feed water sources [13].

Table 1. Global installed desalination capacity by feed water sources [13].

| Feed water sources | Desalination capacity (%) |
|--------------------|---------------------------|
| Wastewater         | 6                         |
| River water        | 8                         |
| Brackish water     | 19                        |
| Sea water          | 67                        |

Desalination processes fall into two main categories, thermal processes or membrane processes. They are subdivided into different types. The three most applied desalination technologies are: Multi-stage Flash (MSF), Reverse Osmosis (RO) and Multi-Effect

Distillation (MED). It was found that during 2013, among the worldwide installed desalination capacity, 65% was based on RO, while MSF accounts for 22% and MED for only 8% [14]. Energy and capital costs are the two largest components of financial cost for both thermal and membrane seawater desalination processes. Future trends in energy costs will also play an important role for the expansion of desalination technologies. Significant increases in energy prices could make desalination technologies less attractive [15,16].

The objectives of this report are to present an overview of current technologies using for desalination of brackish and seawater to produce fresh water and to find out the best technologies for developing countries considering the cost, removal efficiency and other salient features. Discussion of detailed design concepts and processes of desalination and the advantages and disadvantages of these technologies are beyond the scope of this report. Numerous studies have been carried out throughout the world in an attempt to find the suitable technologies but no study has been found specially designed for developing countries.

## 2. History of Desalination

The notable increase in the use of desalination over the past 50 years is to a great extent the result of a long history of research and development efforts. Early research on desalination was conducted during World War II to satisfy freshwater needs in remote locations, and the United States and other countries continued that work after the war [17]. The desalination technologies are commercially available from 1960 and most of these were based on thermal processes. Later multi-stage flash distillation (MSF) processes became popular and the Arabian Gulf was the main area of many commercial plants set up [18]. In the late 1960s, membranes entered the desalination market and were initially used for brackish water treatment. Desalination became a totally commercial enterprise and developments in both thermal and membrane technology by the 1980s which led to an exponential growth in world desalination capacity. The worldwide distribution of desalination capacities is given in Tables 2 and 3 [19].

Table 2. Top 10 countries employing desalination technologies [19].

| Sl. No. | Country total | Capacity<br>(million m <sup>3</sup> /d) | Market share<br>(%) |
|---------|---------------|---|---------------------|
| 1       | Saudi Arabia  | 9.9                                     | 16.5                |
| 2       | USA           | 8.4                                     | 14.0                |
| 3       | UAE           | 7.5                                     | 12.5                |
| 4       | Spain         | 5.3                                     | 8.9                 |
| 5       | Kuwait        | 2.5                                     | 4.2                 |
| 6       | China         | 2.4                                     | 4.0                 |
| 7       | Japan         | 1.6                                     | 2.6                 |
| 8       | Qatar         | 1.4                                     | 2.4                 |
| 9       | Algeria       | 1.4                                     | 2.3                 |
| 10      | Australia     | 1.2                                     | 2.0                 |

For the drinking water purposes, many other countries of the world have begun to utilize desalination as a suitable technology but no other region of the world has implemented desalination on as large a scale as the Middle East. In Europe, Spain and Italy are using the major percentages of desalination capacity [20]. Spain has been using desalination since 1964 to provide drinking water in the Canary Islands, the Balearic Islands, and along the southern and eastern coasts [21-23].

Table 3. Top 10 countries employing seawater desalination technologies [19].

| Rank | Country total | Capacity<br>(million m <sup>3</sup> /d) | Market share<br>(%) |
|------|---------------|---|---------------------|
| 1    | Saudi Arabia  | 7.4                                     | 20.6                |
| 2    | UAE           | 7.3                                     | 20.3                |
| 3    | Spain         | 3.4                                     | 9.4                 |
| 4    | Kuwait        | 2.1                                     | 5.8                 |
| 5    | Qatar         | 1.4                                     | 3.9                 |
| 6    | Algeria       | 1.1                                     | 3.1                 |
| 7    | China         | 1.1                                     | 2.9                 |
| 8    | Libya         | 0.8                                     | 2.3                 |
| 9    | USA           | 0.8                                     | 2.2                 |
| 10   | Oman          | 0.8                                     | 2.2                 |

### 3. Overview of Desalination Technologies

The total global desalination capacity is expected to reach about 100 million m<sup>3</sup>/d by 2015 [25]. The global capacity is increasing day by day because of the significant reduction in desalination cost as a result of significant technological advances [26]. In some specific areas, desalination is now able to successfully compete with conventional water resources and water transfers for potable water supply (e.g., construction of dams and reservoirs or canal transfers) [27]. With the increasing capacity, a variety of desalting technologies has been developed over the years and, based on their commercial success are shown in the Table 4 [24]. Depending on the source water and the desalination technology used, specific elements may vary in their importance in the overall system. For example, inland brackish groundwater desalination facilities will use wells and pumps to bring the source water to the facility, and these systems may need little or no pretreatment. In contrast, seawater reverse osmosis (RO) desalination may use more elaborate intake structures, depending on the specific site conditions, and may require extensive pretreatment.

Table 4. Commercially available desalination technologies [24].

| Thermal                        | Membrane             | Others                |
|--------------------------------|----------------------|-----------------------|
| Multi-stage flash distillation | Reverse osmosis      | Solar humidification  |
| Multi-effect distillation      | Electrodialysis      | Freezing distillation |
| Vapor compression              | Forward Osmosis (FO) | Ion exchange          |

### 3.1. Thermal (distillation) process

This method mimics the hydrological cycle in that salty water is heated producing water vapor that in turn condensed to form fresh water free of salts. The fresh water is mineralized to make it suitable for human consumption. The important factors to be considered for this method of desalination are the proper temperature relative to its ambient pressure and enough energy for vaporization for energy minimization and the control of scale formation.

#### 3.1.1. Multi-stage flash distillation (MSF)

Multi-stage Flash distillation (MSF) accounts for the major portion of desalinated municipal drinking water produced in the world and is used primarily for desalting seawater [24]. MSF units are widely used in the Middle East (particularly in Saudi Arabia, the United Arab Emirates, and Kuwait) and they account for over 22% of the world's desalination capacity [14,15]. The principles of MSF involve evaporation and condensation of water. These steps are coupled in order to recover the latent heat of evaporation for reuse by preheating the incoming water (Fig. 1). To improve the problems with scale formation on heat transfer tubes, a key design feature of MSF systems is bulk liquid boiling [20]. Every stage of an MSF unit functions at a successively lower pressure to maximize water recovery. The low to moderate temperature and pressure steam way out the turbine is used to drive the desalination process [1,28,29]. A performance ratio often applied to thermal desalination processes is the gained output ratio, defined as the mass of water product per mass of heating steam. A typical gained output ratio for MSF units is 8 [1,15,30]. A 20-stage plant has a typical heat requirement of 290 kJ/kg product [1].

The advantages of using multi-stage flash distillation for desalination include the quality of the water produced which containing less than 10 mg/L TDS. The salinity of the feed water does not have much impact on the process or costs of MSF. It can be combined with other processes, e.g., using the heat energy from an electricity generation plant. Besides, some disadvantages of using multi-stage flash distillation for desalination consist of the cost of installation and operation along with the high level of technical knowledge. The recovery ratio is low; therefore, more feed water is required to produce the same amount of product water. Scaling and corrosion are serious concerns because the evaporator components are directly exposed to the feed water.

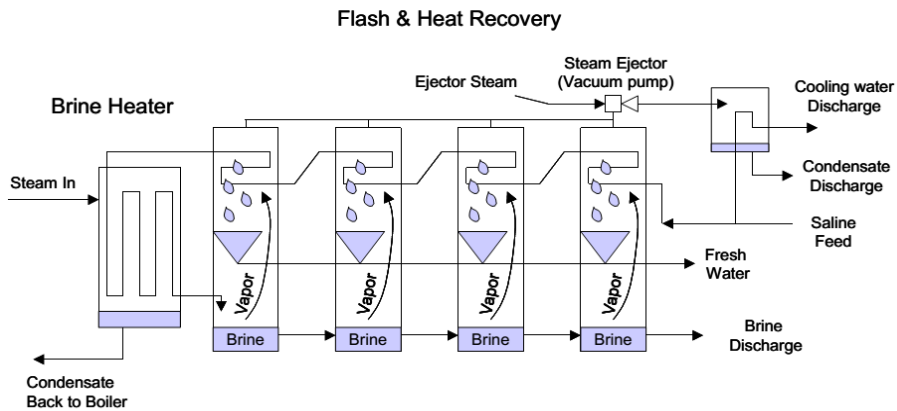

Fig. 1. The Schematic diagram of Multi-Stage Flash Distillation process [20]. The Fig. is used with the permission of Sandia National Laboratories and was copyrighted 2003.

### 3.1.2. *Multi-effects distillation (MED)*

Multi-Effects Evaporation (MEE), also referred to as Multiple Effects Distillation (MSF), is a desalination method that was developed early on and plants were installed in the 1950s. It was a successful attempt in the field of desalination technologies but lost favor and was replaced with MSF due to problems with scaling on the heat transfer tubes [31]. Now a day it is not extensively used but due to the better thermal performance compared to MSF it has gained attention. In MED, vapor from each stage is condensed in the next successive stage thereby giving up its heat to drive more evaporation. Seawater is then sprayed over these hot tubes to evaporate the water. This vapor is then streamed to the next effect. To avoid mixing the boiler chemicals with the pure distillate, the distillate from the first effect does not join the main distillate stream. The brine is collected at the base of each effect, which is either circulated to the next effect or transported out of the system (Fig. 2). To increase the performance, each stage is run at a successively lower pressure. The top boiling temperature in low temperature plant can be as low as 55°C which helps reduce corrosion and scaling, and allows the use of low-grade waste heat. The MEE process can have several different configurations according to the type of heat transfer surface (vertical climbing film tube, rising film vertical tube, or horizontal tube falling film) and the direction of the brine flow relative to the vapor flow (forward, backward, or parallel feed) [31].

The better thermal performance compared with MSF is the main advantage of using multi-effect distillation for desalination. It can operate at a low operating cost when waste heat is used for the distillation process. Lower quality feed water than reverse osmosis (RO) can be used for this process. High operating costs when waste heat is not available for the distillation process and corrosion and scale formation are the main drawbacks of this process.

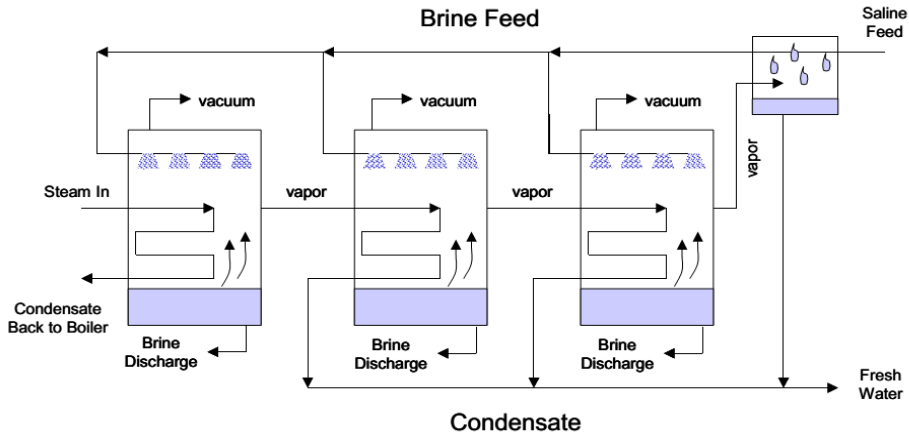

Fig. 2. Schematic diagram of multi-effect distillation evaporator desalination process (horizontal tube-parallel feed configuration) [20]. The Fig. is used with the permission of Sandia National Laboratories and was copyrighted 2003.

### 3.1.3. Vapor compression (VC) distillation

Vapor compression involves evaporating the feed water, compressing the resulting vapor, and then using the pressurized vapor as a heat source to evaporate additional feed water. The compression of the vapor is done either with a mechanical compressor (mechanical vapor compression, MVC) or a steam ejector (thermal vapor compression, TVC). MVC systems generally range up to about 3,000 m<sup>3</sup>/day in size with only a single stage, while TVC systems may range in size to 20,000 m<sup>3</sup>/day having several stages. This difference arises from the fact that MVC systems have the same specific power consumption (power/unit water produced) regardless of the number of stages, while the thermal efficiency of TVC systems is increased by adding additional stages [32]. Thus, the main advantage of adding effects to an MVC system is simply increased capacity. In Fig. 3 mechanical vapor compression, MVC is given.

For the most part, VC processes are practical for small to medium scale installations [24]. The plants are very compact and can be designed to be portable and it does require minimal pre-treatment. The capital cost of the plant is reasonable and operation is simple and reliable. The plants can produce high quality of water from lower quality feed water than RO. But the disadvantages are the requirement of large, expensive steam compressors, which are not readily available. Scaling and corrosion are serious concerns because the evaporator components are directly exposed to the feed water.

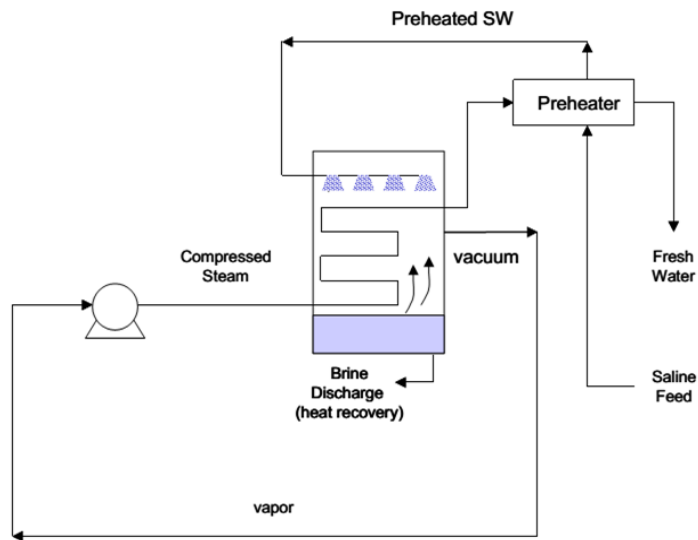

Fig. 3. Schematic diagram of single mechanical vapor compression distillation process [20]. The Fig. is used with the permission of Sandia National Laboratories and was copyrighted 2003.

### 3.2. Membrane process

In membrane processes, a membrane separate two phases allows transporting of one or more components readily than that of other components. The driving force for transport can be a pressure gradient, a temperature gradient, a concentration gradient or an electrical potential gradient. There are mainly two types of membrane process usually used for desalination: reverse osmosis (RO) and electrodialysis (ED). Besides, forward osmosis (FO) is also used in some cases.

#### 3.2.1. Reverse osmosis (RO)

Reverse osmosis (RO) is a membrane separation process where water from a pressurized saline solution is separated from the dissolved salts by flowing through a water-permeable membrane (Fig. 4). The liquid flowing through the membrane is encouraged to flow through the membrane by the pressure differential created between the pressurized feedwater and the product water, which is at near-atmospheric pressure. The remaining feedwater continues through the pressurized side of the reactor as brine. No heating or phase change takes place. The major energy requirement is for the initial pressurization of the feedwater. The operating pressure for brackish water systems ranges from 15- 25 bar and for seawater systems from 54 to 80 bars (the osmotic pressure of seawater is about 25 bar) [24]. The United States ranks second worldwide in desalination capacity, primarily relying on RO to treat brackish and surface water [1].



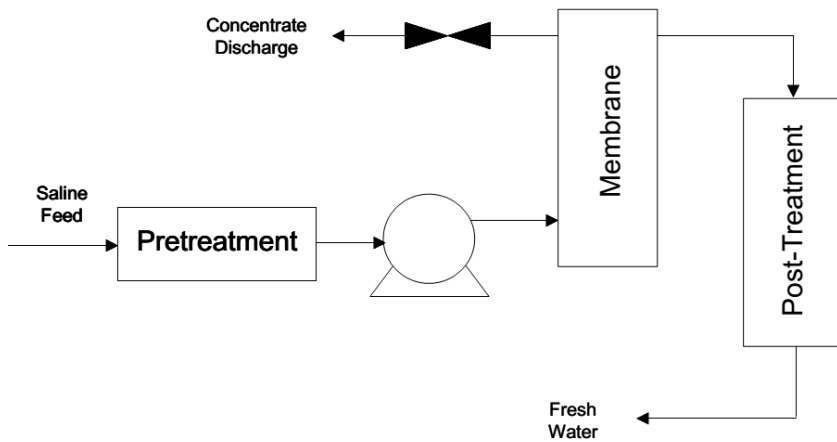

Fig. 4. Block diagram of reverse osmosis operations—optional pressure recovery devices not depicted [20]. The Fig. is used with the permission of Sandia National Laboratories and was copyrighted 2003.

Reverse osmosis can remove from brines not only dissolved solids, but also organic material, colloidal material, and some microorganisms. RO is typically used for brackish water with salt concentrations ranging from 100 to 10,000 ppm. Low pressure membranes have decreased the pressure requirements for some reverse osmosis (RO) operations by up to 50 percent, the efficiency of reverse osmosis (RO) operations will undoubtedly increase and costs decrease as membranes are improved. It can handle a large range of flow rates, from a few liters per day to  $7.5 \times 10^5$  L/day for brackish water and  $4.0 \times 10^5$  L/day for seawater. The capacity of the system can be increased at a later date if required by adding on extra modules. The use of chemicals for cleaning purposes is low. On the other hand, RO membranes are expensive and have a life expectancy of 2-5 years. If the plant uses seawater there can be interruptions to the service during stormy weather. This can cause re-suspension of particles, which increases the extent of suspended solids in the water. Pre-treatment of the feed water is required in order to remove particulates so that the membranes last longer. RO membranes are sensitive to pH, oxidizers, a wide range of organics, algae, and bacteria and of course particulates and other foulants [1]. Therefore, pretreatment of the feed water is an important consideration and can have a significant impact on the cost of RO [30], especially since all the feed water, even the 60% that will eventually be discharged, must be pretreated before being passed to the membrane.

### 3.2.2. Electrodialysis (ED)

Electrodialysis is a mature process which is applied since more than 50 years on a large industrial scale for the production of potable water from brackish water sources [33]. In electrodialysis (ED) system, a direct current is passed through the water, which drives the ions (not the water) through membranes to electrodes of opposite charge [24]. Unlike RO

or distillation, ED is only capable of removing ionic components from solution since the driving force for the separation is an electric field. ED utilizes electromotive force applied to electrodes adjacent to both sides of a membrane to separate dissolved minerals in water. The separation of minerals occurs in individual membrane units called cell pairs. A cell pair consists of an anion transfer membrane, a cation transfer membrane, and two spacers. The complete assembly of cell pairs and electrodes is called the membrane stack (Fig. 5). The number of cells within a stack varies depending on the system. Since the resistance in the stack changes from top to bottom, the separation is typically carried out in a series of small steps. This makes the process more economical and easier to control [1]. Like RO, the energy required to separate the ions from solution increases with concentration, thus ED is generally limited to brackish waters containing only a few thousand ppm of dissolved solids [1].

ED system separates without phase change which results in relatively low energy consumption. When brackish water is desalted by ED system, the product water needs only limited pre-treatment, typically only chlorination for disinfection. This system is particularly suitable for separating non-ionized from ionized components because ED system removes only ionized species. Another advantage is that the osmotic pressure is not a factor in ED system, so the pressure can be used for concentrating salt solutions to 20% or higher. Though ED system is suitable for separating ionic substances, it cannot remove the organic matter, colloids and suspended solids. Selection of materials for membranes and stack is another important issue to ensure compatibility with the feed stream.

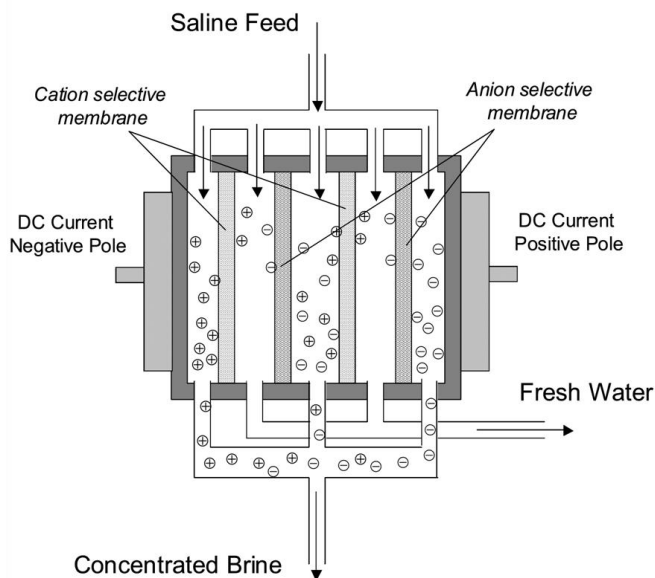

Fig. 5. Schematic diagram of electrodesalination (ED) desalination process [20]. The Fig. is used with the permission of Sandia National Laboratories and was copyrighted 2003.

### 3.2.3. Forward osmosis (FO)

Forward (or direct) osmosis (FO) is a membrane separation process where water transports across a semi-permeable membrane that is impermeable to salt utilizing an osmotic pressure gradient. This process may have the ability to desalinate saline water sources at a reduced cost and at high recovery with the use of osmotic driving forces which can be significantly greater than hydraulic driving forces in RO [34]. In the FO process, the osmotic pressure gradient generated by a highly concentrated solution (known as “draw” solution) to allow water to diffuse through a semi-permeable membrane from a saline feed water, which has a relatively lower concentration (Fig. 6). Consequently, a less concentrated draw solution is being produced which may be further treated to extract freshwater. With the use of a suitable draw solution, very high osmotic pressure driving forces can be generated to achieve high recoveries that, in principle, can lead to salt precipitation. The saline feed water is fed to the FO unit, which, in principle, can incorporate spiral wound or hollow fiber membrane modules. The feed water and draw solution flow tangent to the membrane in a cross-flow mode. Through osmosis, water transports from the seawater across the salt rejecting membrane and into the draw solution. To yield potable water, the diluted draw solution is sent to a separation unit, comprising a distillation column or a membrane gas separation unit. The separated draw solution is recycled back to the FO unit. The FO process is characterized by relatively low fouling potential, low energy consumption, simplicity, and reliability [36].

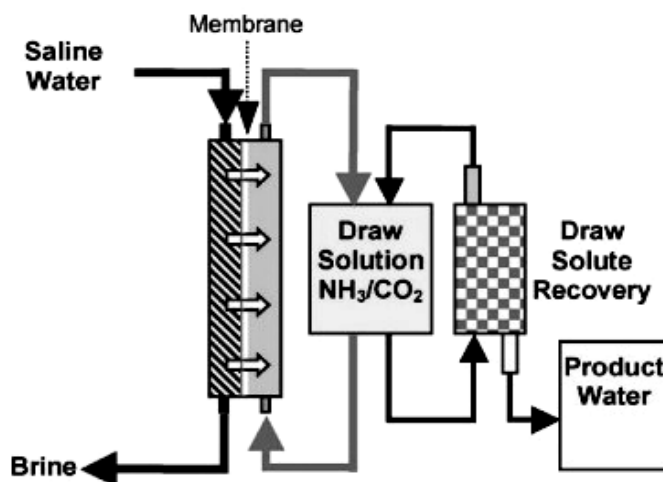

Fig. 6. Forward osmosis process schematic [35]. The Fig. is reproduced with the permission from publisher.

### 3.3. Alternative technologies

Besides the commercially available desalination technologies, a number of other processes have been developed to desalinate seawater. These processes could not reach

the level of commercial success that MSF, MED, and RO have, but they may become valuable under special circumstances or with further development. These important processes include solar humidification and membrane distillation.

### 3.3.1. *Solar humidification (SH)*

The solar humidification is a thermal water desalination method. It is based on evaporation of sea water or brackish water and consecutive condensation of the generated humid air, mostly at ambient pressure. This process mimics the natural water cycle, but over a much shorter time frame. The basic design of a solar still, which is similar to a greenhouse, is shown in Fig. 7. Through the transparent glass, solar energy enters to the device and produce heat which evaporates the water inside it. The basin for salt water is typically black in color to increase the efficiency of absorbing the solar energy. The evaporated water then condenses on the cooler glass panels and the condensed droplet run down the panels and collected for use.

The advantages of the solar humidification process are its relative simplicity to operate and service and obviously its ability to use solar or other renewable power as its source of energy, hence operating costs are very low. However, the efficiency of this type of plants is less than 50% which make them non-viable for use [28]. A general rule of thumb is that about 1 m<sup>2</sup> of ground will produce only 4 liters per day of freshwater [24]. Accordingly, to produce large amount of fresh water, it is important to use very inexpensive materials of construction to minimize capital costs because huge area is needed. Even so, the installation costs of solar stills tend to be considerably higher than other methods [24]. In addition, the stills are vulnerable to weather damage.

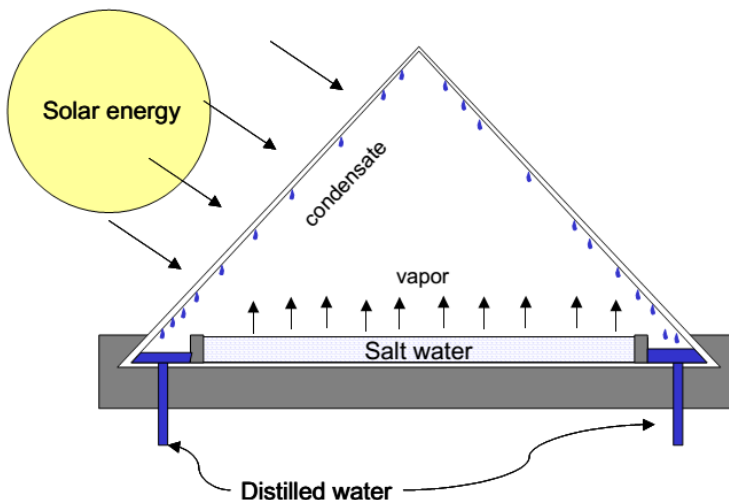

Fig. 7. The basic design of a solar distillation unit [20]. The Fig. is used with the permission of Sandia National Laboratories and was copyrighted 2003.

### 3.3.2. Membrane distillation (MD)

Membrane distillation (MD) is a thermally driven separation program in which separation is enabled due to phase change and becoming an emerging technology [20]. The state of art process of MD that separate mass flows by a membrane, mostly use a static pressure difference as the driving force between the two bounding surfaces, a difference in concentration (dialysis) or an electric field (ED). Selectivity of a membrane is produced by its pore size in relation to the size of the substance to be retained, its diffusion coefficient or electrical polarity. However, the selectivity of membranes used for membrane distillation (MD) is based on the retention of liquid water with-at the same time- permeability for free water molecules and thus, for water vapor. These membranes are made of hydrophobic synthetic material (e.g. PTFE, PVDF or PP) and offer pores with a standard diameter between 0.1 to 0.5  $\mu\text{m}$ . The schematic of a MD is given in Fig. 8.

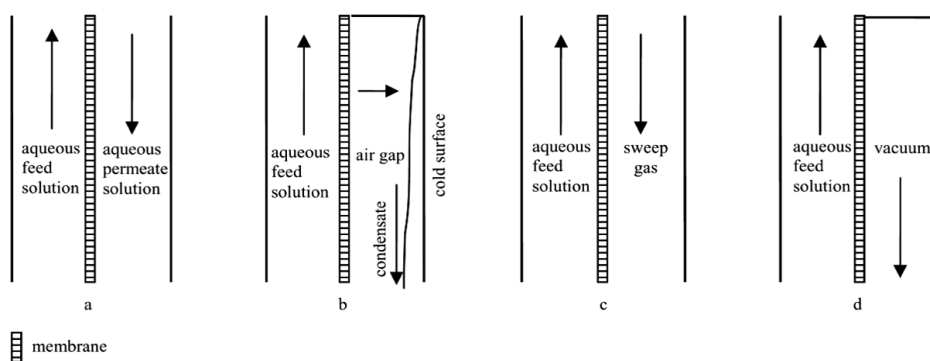

Fig. 8. MD configurations, (a) direct contact MD, (b) air gap MD, (c) sweep gas MD, and (d) vacuum MD [37]. The Fig. is reproduced with the permission of publisher.

The use of MD is advantageous over some other separation processes because it requires lower operating temperatures and pressures than conventional distillation, reduced chemical interaction between membrane and process solutions, reduced vapor spaces compared to conventional distillation processes. The primary limitation arises from the defining phenomenon itself: the process solutions must be aqueous and sufficiently dilute to prevent wetting of the hydrophobic micro-porous membrane. This limits MD to applications in desalination [37].

## 4. Advantages and Disadvantages of Different Desalination Technologies

Over the years desalination technologies for water production have been increased as a result of technological advances as well as for the demand of fresh water supply. At the same time, the costs of obtaining and treating water from conventional sources have risen due to the increased levels of treatment required to comply with more stringent water quality standards [38]. For the production of fresh water from the saline water, a choice

among the commercially available desalination technologies largely depends on how the process applies in some specific conditions, together with both technical and economic considerations [39]. All the individual technologies have their relative pros and cons and are summarized in the following Table 5 [40].

Table 5. The relative pros and cons identified for the seawater desalination technologies [40].

| Process | Recovery and total dissolved solids  | Pros   | Cons  |
|---------|--|--|---|
| MSF     | 25–50% recovery in high temperature recyclable MSF plant<br><br><50 mg/L TDS | Lends itself to large capacity designs<br>Proven, reliable technology with long operating life<br>Flashing rather than boiling reduces incidence of scaling<br>Minimal pre-treatment of feed water required<br>High quality product water<br>Plant process and cost independent of salinity level<br>Heat energy can be sourced by combining with power generation | Large capital investment required<br>Energy intensive process<br>Larger footprint required (land and material)<br>Corrosion problems if materials of lesser quality used<br>Slow start-up rates<br>Maintenance requires entire plant to shut-down<br>High level of technical knowledge required<br>Recovery ratio low |
| MED     | 0–65% recovery possible<br><br><10 mg/L TDS                                  | Large economies of scale<br>Minimal pre-treatment of feed water required<br>Very reliable process with minimal requirements for operational staff<br>Tolerates normal levels of suspended and biological matter<br>Heat energy can be sourced by combining with power generation<br>Very high-quality product water  | High energy consumption<br>High capital and operational cost<br>High quality materials required as process is susceptible to corrosion<br>Product water requires cooling and blending prior to being used for potable water needs   |
| VC      | ~50% recovery possible<br><10 mg/L TDS                                       | Developed process with low consumption of chemicals<br>Economic with high salinity (>50,000 mg/L) Smaller economies of scale (up to 10,000 m <sup>3</sup> /d)<br>Relatively low energy demand<br>Lower temperature requirements reduce potential of scale and corrosion<br>Lower capital and operating costs   | Start-up require auxiliary heating source to generate vapor<br>Limited to smaller sized plants<br>Compressor needs higher levels of maintenance   |

Portable designs allow flexibility

|    |   |  |   |
|----|---|--|---|
| RO | 30–60% recovery possible for single pass (higher recoveries are possible for multiple pass or waters with lower salinity) <500 mg/L TDS for seawater possible and <less 200 mg/L for brackish water | Lower energy consumption<br>Relatively lower investment cost<br>No cooling water flow<br>Simple operation and fast startup<br>High space/production capacity<br>Removal of contaminants other than salts achieved<br>Modular design<br>Maintenance does not require entire plant to shutdown | Higher costs for chemical and membrane replacement<br>Vulnerable to feed water quality changes<br>Adequate pre-treatment a necessity<br>Membranes susceptible to biofouling<br>Mechanical failures due to high pressure<br>Appropriately trained personnel recommended<br>Membrane life expectancy around 5–7 years |
| ED | 85–94% recovery possible<br>140–600 mg/L TDS  | Energy usage proportional to salts removed not volume treated<br>Higher membrane life of 7–10 years<br>Operational at low to moderate pressures  | Leaks may occur in membrane stacks<br>Bacterial contaminants not removed by system and post-treatment required for potable water use  |

## 5. Comparison of Salient Features of Different Desalination Technologies

A wide range of technical parameters to be evaluated includes energy requirement, efficiency and performance ratio, scale and fouling, corrosion, thermal discharge and operating temperature, quality o feed water etc. On the other hand, the economic analysis is based on cost determining factors such as capital, energy, labor, chemicals, materials, and consumables [39-42]. Numerous analyses and comparisons have been carried out to assess competing technologies and economics.

### 5.1. Energy requirement

Energy requirement is the primary concern of choosing the suitable desalination technologies [43]. The energy requirements for the MSF, MED, and VC are virtually independent of salt concentration, while the energy requirements for the membrane processes are highly dependent on concentration [20]. Therefore, RO process has gained much popularity and had developed direct competition with distillation processes. Although the most efficient process is not always the most cost-effective design but the energy consumption must be considered especially for the area where there is a shortage of available energy supplies [20]. A summarization of the energy consumption by different desalination technologies are given in the following Table 6.

Table 6. The Energy consumption by different Desalination technologies (kJ/kg fresh water – divide by 3.6 for kWh/m<sup>3</sup>) [20].

| Desalination Technologies | Energy Consumption | References |
|---------------------------|--------------------|------------|
| MSF                       | 299                | [43]       |
|                           | 230                | [29]       |
| MED                       | 152                | [45]       |
|                           | 25-43              | [25]       |
| VC                        | 14-29              | [32]       |
|                           | 61                 | [44]       |
| RO                        | 27                 | [29]       |
|                           | 14-20              | [46]       |
|                           | 14 (7.2**)         | [47]       |
|                           | 18-24              | [48]       |
| ED                        | 0.4-1.8            | [49]       |

From the Table 6, it is apparent that the energy consumption of the thermal processes (MSF, MED and VCD) is much higher than the membrane processes (RO and ED). RO is a newer technology with recent improvements in energy recovery. But it is important to consider that RO consumes energy in the form of electricity whereas MSF uses heat more directly. The conversion of thermal energy to electrical energy is only about 35% efficient. Therefore, on a fuel basis, RO consumes 9-30 times the theoretical energy requirement [20].

### 5.2. Removal efficiency and performance ratio

Removal efficiency of RO and NF are best among all of the process. The removal efficiency of the MED and MSF are lower compare to RO and VC. Similar result for the performance ratio was also found in the literature [59]. Fig. 9 represents the performance ratio of different desalination technologies. From this Fig., it was found that the membrane process has higher performance ratio compare to the thermal process. Reverse osmosis stands for the highest performance ratio (from 30-100 Kg/2326 kj) and multi stage filtration has the lowest performance ratio and amounts to 6.4 Kg/2326 kj.

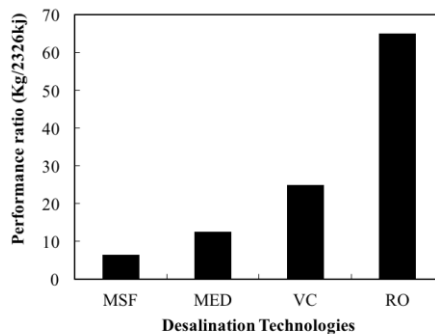

Fig. 9. Performance ratio of different desalination technologies [50]. The Fig. is reproduced with the permission from publisher.



### 5.3. Corrosion, scaling and fouling

The disadvantages of maximum desalination plant are the sensitivity to fouling e.g. by suspended solids, and to damage by oxidized compounds such as chlorine or chlorine oxides. Pretreatment is usually needed to ensure a stable performance of the module; optimization of the pretreatment is one of the most critical aspects [1]. Scaling (due to CaCO<sub>3</sub>, CaSO<sub>4</sub>, and BaSO<sub>4</sub> etc.) is another possible problem, which depends on the recovery ratio of, permeate production and feed. Corrosion, scaling and fouling problem are more serious in thermal process compare to the membrane process.

### 5.4. Quality of feed water

The quality of feed water determines the degree of pretreatment necessary for the process and determines the costs needed in this step. Considering the feed water quality, in RO, the quality of feed water should be very good, because the feed water not being pre-treated satisfactorily causes most failures in RO systems. In RO, pretreatment of feed water is required, often stricter in order to remove particulates so that the membranes last longer. In ED, additional measures may be required for disinfection and removal of particles. In case of MSF, MED and VCD, it is not necessary to pretreat the feed water. As a result, the cost of thermal process is lower compare to the membrane process.

The comparison of all salient features of different desalination technologies are shown in Table 7. The technologies that bear the best salient features are marked by shaded area.

Table 7. Comparison of all salient features of different desalination technologies [43].

| Salient features |     | Energy Requirement | Efficiency and Performance Ratio | Scale and Fouling | Corrosion | Thermal Discharge | Water Recovery | Quality of Feed Water |
|------------------|-----|--------------------|----------------------------------|-------------------|-----------|-------------------|----------------|-----------------------|
| Technologies     | MSF | 4                  | 2                                | 3                 | 4         | 4                 | 2              | 3                     |
|                  | MED | 4                  | 2                                | 4                 | 4         | 4                 | 2              | 3                     |
|                  | VC  | 4                  | 3                                | 4                 | 4         | 4                 | 2              | 3                     |
|                  | ED  | -                  | 3                                | 2                 | 1         | 0                 | 4              | 2                     |
|                  | RO  | 2                  | 4                                | 3                 | 3         | 0                 | 3              | 4                     |

Index value 0: none, 1: low, 2: medium, 3: high, and 4: extreme

## 6. The Economics of Desalination

Cost is the major factor in implementing the desalination technologies. The cost analysis of desalination technologies are usually aims to estimate the production cost per unit of fresh water, and calculates the contribution of each cost item to the total cost. This

analysis helps to consider the best technologies. In general, cost factors associated with implementing a desalination plant are site specific and depend on several variables including feed water quality, plant capacity, site characteristics, costs associated with water intake, pretreatment, and Regulatory requirements which associated with meeting local/state permits and regulatory requirements [51-54]. Large capacity plants require high initial capital investment compared to low capacity plants. But due to the economy of scale, the unit production cost for large capacity plants can be lower [52,53]. Table 8 summarizes a comparative study of desalination process costs.

Table 8. The cost of per unit produced freshwater from different desalination technologies [55].

| Desalination technologies | Cost of water produced freshwater (US\$/m <sup>3</sup> )  |
|---------------------------|---|
| MSF                       | 0.9–1.5<br>(Cost reduces with cogeneration and capacity [56] but 4 if fossil fuel price is US\$ 100/barrel oil [57])<br>Solar pond: 0.8–5.5* [58]<br>Solar collector: 2.5–9.0* [58] |
| MED                       | ~1, lower with cogeneration and use of TVC; 0.83 for Jubail II plant [59-60]<br>Solar pond: 0.5–3.7* [58]<br>Solar collector: 0.7–9.3* [58]   |
| RO                        | SW: 0.99; 0.53 at Ashkelon plant<br>BW: 0.2–0.7 [58-59,62]<br>Solar PV: BW: 5–7<br>SW: 9–12 €/m <sup>3</sup> [63]   |
| ED                        | BW: 0.6 [64]  |

SW: seawater; BW: brackish water

\* Based on models and experiments

RO and ED are usually used for both seawater and brackish water whereas others are only for seawater desalination. In comparison with seawater desalination, brackish water desalination cost is lower due to low TDS concentration in feed water for brackish water requires less energy for treatment compared to high TDS feed water (seawater). Low TDS allows for higher conversion rates and the plant can operate with less dosing of antiscalant chemicals. The pre-treatment of surface waters such as tidal waters will be costlier compared to brackish groundwater because of the potential existence of more contaminants in these waters. The capital cost of MSF/MED is generally costlier than RO and hence the number of operating RO plants is increasing worldwide [26]. This trend towards selective use of RO over a thermal process reflects the flexibility and simplicity of bidding requirements for the RO process. In compare with MSF and MED, the RO and ED process cost is less and also capable to desalinate both brackish and seawater. Keeping this in consideration, it is better to use RO or ED to desalinate water.

## 7. Conclusion

It is quite difficult to decide that which method is best suited for desalination in developing countries because all the desalination technologies have their specific advantages and disadvantages. Distillation plants normally have higher energy requirements and unit capital cost than membrane plants. Corrosion, scaling and fouling problem are more serious in thermal process compare to the membrane process. Huge amount of waste heat is produced in the distillation processes. On the other hand, membrane processes do not destroy biological substances, unlike distillation processes and pretreatment is of the feed water is required in order to remove particulate so that the membranes last longer. However, in cease of MSF, MED and VC, it is not necessary to pre-treat the feed water. The unit capital cost in desalinate brackish water is lower compare to desalinate seawater and the cost is lower in RO and EDR. Therefore, as in developing country, the main problem is with energy sources and brackish water, so it is wise to use RO or EDR to desalinate the water.

## References

1. R. Semiat, *Water Int.* **25**(1), 54 (2000). <https://doi.org/10.1080/02508060008686797>
2. G. Fiorenza, V. K. Sharma, and G. Braccio, *Energy Conv. Manag.* **44**(14), 2217 (2003). [https://doi.org/10.1016/S0196-8904\(02\)00247-9](https://doi.org/10.1016/S0196-8904(02)00247-9)
3. CA (Comprehensive Assessment of Water Management in Agriculture) *Water for Food, Water for Life: A Comprehensive Assessment of Water Management in Agriculture* (London, UK: Earthscan and Colombo, Sri Lanka; IWMI, 2007).
4. U. N. Water, *Coping with Water Scarcity—Challenge of the 21st Century*, Campaign Material for World Water Day, March, 22 (2007).
5. M. A. Eltawil, Z. Zhengming, and L. Yuan, *Renewable Energy Powered Desalination Systems: Technologies and Economics-state of the Art - Twelfth International Water Technology Conference* (Alexandria, Egypt, 2008).
6. WHO (World Health Organization). *Desalination for Safe Water Supply: Guidance for the Health and Environmental Aspects Applicable to Desalination* (Public Health and the Environment World Health Organization, Geneva, 2007).
7. M. Radmor, J. Strauss, J. Bishop, G. Piatt, K. DeGroat, D. Fargo, D. Eisemann, and C. Mulligan, *Desalination and Water Purification Technology Roadmap (No. BR-DWPR-95)*, Bureau of Reclamation Denver Co. (2003).
8. A. Zander, M. Elimelech, D. Furukawa, P. Gleick, K. Herd, K. L. Jones, P. Rolchigo, and W. W. Wood, National Research Council, *The National Academies* (2008).
9. I. Alatiqi, H. Ettouney, and H. El-Dessouky, *Desalination* **126**(1), 15 (1999). [https://doi.org/10.1016/S0011-9164\(99\)00151-4](https://doi.org/10.1016/S0011-9164(99)00151-4)
10. M. H. Dore, *Desalination* **172**(3), 207(2005). <https://doi.org/10.1016/j.desal.2004.07.036>
11. U. Ebersperger and P. Isley, *Review of the Current State of Desalination Water Policy Working Paper 2005-008* (Georgia State University. Environmental Policy Program, Water Policy Centre, 2005).
12. M. Schiffler, *Desalination* **165**, 1(2004). [https://doi.org/10.1016/S0011-9164\(04\)00207-3](https://doi.org/10.1016/S0011-9164(04)00207-3)
13. ESCWA (Economic and Social Commission for Western Asia). *Role of Desalination in Addressing Water Scarcity. ESCWA Water Development Report 3. United Nations Publication* (United Nations, New York, 2015). <http://www.escwa.un.org/information/publications/edit/upload/sdpc-09-4.pdf>
14. S. Miller, H. Shemer, and R. Semiat, *Desalination* **366**, 2 (2015).

- <https://doi.org/10.1016/j.desal.2014.11.034>
15. H. M. Ettouney, H. T. El-Dessouky, R. S. Faibish, and P. J. Gowin, *Chem. Eng. Prog.* **98**(12), 32 (2002).
  16. S. Chaudhry, Unit Cost of Desalination. California Desalination Task Force, California Energy Commission (Sacramento, California, 2003).
  17. H. Cooley, P. H. Gleick, and G. H. Wolff, *Desalination, with a Grain of Salt: a California Perspective*. Oakland, CA: Pacific Institute for Studies in Development, Environment, and Security (2006).
  18. K. V. Reddy and N. Ghaffour, *Desalination* **205**(1), 340 (2007).  
<https://doi.org/10.1016/j.desal.2006.03.558>
  19. M. Nair and D. Kumar, *Desalination Water Treat.* **51**(10-12), 2030 (2013).  
<https://doi.org/10.1080/19443994.2013.734483>
  20. J. E. Miller, Review of Water Resources and Desalination Technologies. Sandia National Labs Unlimited Release Report SAND-2003-0800 (2003).
  21. P. Palomar and I. J. Losada, *Desalination* **255**(1), 97 (2010).  
<https://doi.org/10.1016/j.desal.2010.01.008>
  22. J. A. Reverter, S. Talo, and J. Alday, *Desalination* **138**(1), 207 (2001).  
[https://doi.org/10.1016/S0011-9164\(01\)00266-1](https://doi.org/10.1016/S0011-9164(01)00266-1)
  23. S. Rybar, M. Vodnar, F. L. Vartolomei, R. L. Méndez, and J. B. L. Ruano, Experience with Renewable Energy Source and SWRO Desalination in Gran Canaria - *SP05-100 International Desalination Association World Congress* (2005).
  24. O. K. Buros, *The ABCs of Desalting* Topsfield, MA: International Desalination Association, (2000). pp. 30.
  25. G. W. Intelligence, Market Profile and Desalination Markets, 2009–2012 Yearbooks and GWI website (2013).
  26. N. Ghaffour, T. M. Missimer, and G. L. Amy, *Desalination* **309**, 197 (2013).  
<https://doi.org/10.1016/j.desal.2012.10.015>
  27. K. Quteishat, Desalination and Energy Saving and Recovery - *Middle East Waste & Water Congress* (Dubai—UAE, May 2008).
  28. K. S. Spiegler, Y. M. El-Sayed, and A. D. Primer, *Balaban Desalination Publications* (Santa Maria Imbaro, 1994).
  29. M. A. Darwish and N. M. Al-Najem, *Appl. Therm. Eng.* **20**(5), 399 (2000).  
[https://doi.org/10.1016/S1359-4311\(99\)00032-0](https://doi.org/10.1016/S1359-4311(99)00032-0)
  30. H. T. El-Dessouky, H. M. Ettouney, and Y. Al-Roumi, *Chem. Eng. J.* **73**(2), 173 (1999).  
[https://doi.org/10.1016/S1385-8947\(99\)00035-2](https://doi.org/10.1016/S1385-8947(99)00035-2)
  31. M. Al-Shammiri and M. Safar, *Desalination* **126**(1), 45 (1999).
  32. F. Mandani, H. Ettouney, and H. El-Dessouky, *Desalination* **128**(2), 161 (2000).  
[https://doi.org/10.1016/S0011-9164\(00\)00031-X](https://doi.org/10.1016/S0011-9164(00)00031-X)
  33. H. Strathmann, *Desalination* **264**(3), 268 (2010). <https://doi.org/10.1016/j.desal.2010.04.069>
  34. J. R. McCutcheon, R. L. McGinnis, and M. Elimelech, *J. Membr. Sci.* **278**(1), 114 (2006).  
<https://doi.org/10.1016/j.memsci.2005.10.048>
  35. R. Semiat and D. Hassan, Energy Issues in Desalination Processes - *First UK-Israeli Workshop and Research Event on the Application of Membrane Technology in Water Treatment and Desalination* (St Hilda's College, Oxford, 2008)
  36. T. Y. Cath, S. Gormly, E. G. Beaudry, M. T. Flynn, V. D. Adams, and A. E. Childress, *J. Membr. Sci.* **257**(1), 85 (2005). <https://doi.org/10.1016/j.memsci.2004.08.039>
  37. K. W. Lawson and D. R. Lloyd, *J. Membr. Sci.* **124**(1), 1 (1997).  
[https://doi.org/10.1016/S0376-7388\(96\)00236-0](https://doi.org/10.1016/S0376-7388(96)00236-0)
  38. A. D. Khawaji, I. K. Kutubkhanah, and J. M. Wie, *Desalination* **221**(1), 47 (2008).  
<https://doi.org/10.1016/j.desal.2007.01.067>
  39. A. D. Khawaji, J. M. Wie, and A. A. Al-Mutairi, Technical and Economic Seawater MSF and RO Desalination Processes for Madinat Yanbu Al-Sinaiyah - *Proceedings of the IDA World Congress on Desalination and Water Reuse* (Manama, Bahrain, March 2002).

40. M. A. Eltawil, Z. Zhengming, and L. Yuan, *Renew. Sust. Energ. Rev.* **13(9)**, 2245 (2009).  
<https://doi.org/10.1016/j.rser.2009.06.011>
41. M. A. Darwish, M. A. Jawad, and G. S. Aly, *Desalination* **76**, 281 (1989).  
[https://doi.org/10.1016/0011-9164\(89\)87051-1](https://doi.org/10.1016/0011-9164(89)87051-1)
42. N. M. Wade, *Desalination* **93(1)**, 343 (1993). [https://doi.org/10.1016/0011-9164\(93\)80113-2](https://doi.org/10.1016/0011-9164(93)80113-2)
43. L. Wagner, *Water Desalination-Tap into the Liquid Gold. Analyst* (2007).
44. R. V. Wahlgren, *Water Res.* **35(1)**, 1 (2001). [https://doi.org/10.1016/S0043-1354\(00\)00247-5](https://doi.org/10.1016/S0043-1354(00)00247-5)
45. V. Dvornikov, *Desalination* **127(3)**, 261 (2000).  
[https://doi.org/10.1016/S0011-9164\(00\)00015-1](https://doi.org/10.1016/S0011-9164(00)00015-1)
46. M. Wilf and K. Klinko, *Desalination* **138(1)**, 299 (2001).  
[https://doi.org/10.1016/S0011-9164\(01\)00278-8](https://doi.org/10.1016/S0011-9164(01)00278-8)
47. P. Glueckstern, A. Thoma, and M. Priel, *Desalination* **139(1)**, 217 (2001).  
[https://doi.org/10.1016/S0011-9164\(01\)00313-7](https://doi.org/10.1016/S0011-9164(01)00313-7)
48. R. Rautenbach and K. Voßenkaul, *Sep. Purif. Technol.* **22**, 193 (2001).  
[https://doi.org/10.1016/S1383-5866\(00\)00130-1](https://doi.org/10.1016/S1383-5866(00)00130-1)
49. M. Demircioğlu, N. Kabay, E. Ersöz, I. Kurucaovali, Ç. Şafak, and N. Gizli, *Desalination* **136(1)**, 317 (2001). [https://doi.org/10.1016/S0011-9164\(01\)00194-1](https://doi.org/10.1016/S0011-9164(01)00194-1)
50. A. Malek, M. N. A. Hawlader, and J. C. Ho, *ASEAN J. Sci. Technol. Devt.* **9(2)**, 41 (1992).
51. Cost Estimating Procedures, In: *Desalting Handbook for Planners* (Chapter 9), United States Department of Interior, Bureau of Reclamation, Technical Service Center, Desalination and Water Purification Research and Development Program Report No. 72, Edition 3<sup>rd</sup> (2003). pp. 187–231.
52. LBG-Guyton Associates. *Brackish Groundwater Manual for Texas Regional Water Planning Groups*. LBG-Guyton Associates (2003). pp. 31.
53. T. M. Younos, *The Feasibility of using Desalinations to Supplement Drinking Water Supplies in Eastern Virginia*. VWRRC Special Report SR25-2004. Blacksburg, VA: (Virginia Water Resources Research Center, Virginia Tech., 2004) pp. 114.
54. T. Younos and J. Contemp. *Water Res. Edu.* **132(1)**, 39 (2005).
55. J. Bundschuh, N. Ghaffour, H. Mahmoudi, M. Goosen, S. Mushtaq, and J. Hoinkis, *Renew. Sust. Energ. Rev.* **43**, 196 (2015). <https://doi.org/10.1016/j.rser.2014.10.102>
56. T. Winter, D. J. Pannell, and L. M. McCann, *The Economics of Desalination and its Potential Application to Australia- 2002 Conference (46th)*, (Australian Agricultural and Resource Economics Society, Canberra (No. 125611) 2002).
57. A. N. A. Mabrouk, A. S., Nafey, and H. E. Fath, *Desalin. Water Treat.* **22(1-3)**, 56 (2010).  
<https://doi.org/10.5004/dwt.2010.1537>
58. C. Li, Y. Goswami, and E. Stefanakos, *Renew. Sust. Energ. Rev.* **19**, 136 (2013).  
<https://doi.org/10.1016/j.rser.2012.04.059>
59. Global Water Intelligence, *Water Desalination Report 45(17)*, (2009)
60. Y. Zhou and R. S. Tol, *Water Resour. Res.* **41(3)**, (2005).  
<https://doi.org/10.1029/2004WR003749>
61. Global Water Intelligence, *Water Desalination Report 45(2)*, (2009).
62. B. Sauvet-Goichon, *Desalination* **203(1)**, 75 (2007).  
<https://doi.org/10.1016/j.desal.2006.03.525>
63. M. Papapetrou, C. Biercamp, and M. Wiegghaus, *Roadmap for the Development of Desalination Powered by Renewable Energy: Promotion for Renewable Energy for Water Production through Desalination* (Fraunhofer Verlag, 2010).
64. H. Shih, *Desalination* **182(1)**, 461 (2005). <https://doi.org/10.1016/j.desal.2005.02.038>